

UNEK6170Z

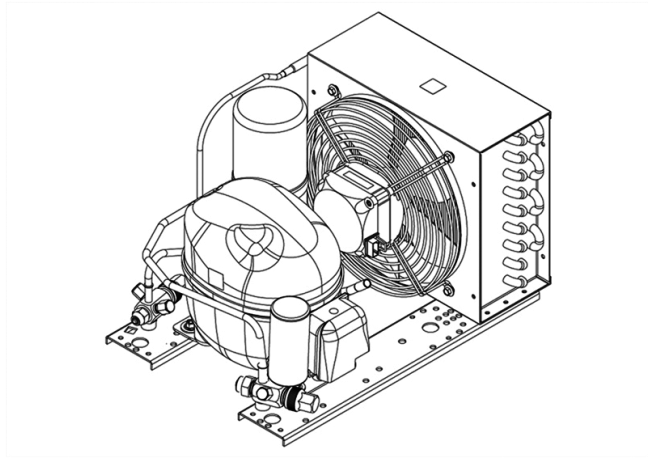

CE

ENGINEERING CODE
573DA5212AA

REFRIGERANT
R-513A

POWER SUPPLY
220-240 V 50 Hz

APPLICATION
HBP

MOTOR TYPE
CSIR

STANDARD
EN13215_RG20

COOLING CAPACITY
443 W

EFFICIENCY
1.6 W/W

DATA

GENERAL DATA

Model	UNEK6170Z
-------	-----------

ELECTRICAL DATA

Locked Rotor Amperage (LRA)	12.40 A
-----------------------------	---------

Rated Load Amperage (RLA)	2.35 A
---------------------------	--------

Maximum Overcurrent Protection (MOP)	5.29 A
--------------------------------------	--------

Minimum Current Ampacity (MCA)	2.9 A
--------------------------------	-------

ACCESSORIES

Discharge valve	FLARE 1/4"	2110025
-----------------	------------	---------

Suction valve	FLARE 3/8"	2110024
---------------	------------	---------

CONDENSING COMPONENTS

Compressor	NEK6170Z	M/HBP
------------	----------	-------

Condenser	3R9T	2451205
-----------	------	---------

Refrigerant	R-134a
-------------	--------

Expansion Device	C-V
------------------	-----

Fan Blade Diameter	230 mm
--------------------	--------

Fankit	10W 230/31/5B	1996580
--------	---------------	---------

MECHANICAL DATA

Air Flow	420 m ³ /h
Height	254 mm
Receiver	1.1 L
Shaft Power	10 W
Weight	17 Kg
Width	300 mm
Length	435 mm

PERFORMANCE

TESTED CONDITIONS

Tested Refrigerant	R-513A
Tested Application	HBP
Tested Standard	EN13215_RG20

RATED POINTS

Ambient Temperature °C	Evaporating Temperature °C	Cooling Capacity W	Efficiency W/W	Consumo de Potencia W
32	-10	443	1.6	276

Test Condition: Subcooling 3 K, Return Gas 20 °C.

PERFORMANCE CURVE

Ambient Temperature 25°C

Evaporating Temperature °C	Cooling Capacity W	Efficiency W/W	Consumo de Potencia W
-15	402	1.63	246
-5	589	2.01	293
0	699	2.20	318
5	819	2.39	343
10	949	2.56	370

Test Condition: Subcooling 3 K, Return Gas 20 °C.

PERFORMANCE CURVE

Ambient Temperature 32°C

Evaporating Temperature °C	Cooling Capacity W	Efficiency W/W	Consumo de Potencia W
-15	364	1.44	253
-5	532	1.77	300
0	632	1.94	325
5	742	2.11	351
10	862	2.28	379

Test Condition: Subcooling 3 K, Return Gas 20 °C.

PERFORMANCE CURVE

Ambient Temperature 43°C

Evaporating Temperature °C	Cooling Capacity W	Efficiency W/W	Consumo de Potencia W
-15	283	1.07	264
-5	428	1.34	320
0	516	1.48	350
5	614	1.61	381

Test Condition: Subcooling 3 K, Return Gas 20 °C.

ENVELOPE



EXTERNAL DIMENSIONS

